



INDUSTRIES WE SERVE



REAL ESTATE



POWER PLANTS



ROAD BRIDGES



METRO PLANTS



PORT & SHIPYARDS



About Us

ORANGE Machinetech Pvt Ltd. is one of the leading organization for After Sales Support of Construction Equipment in India. We provide a complete solution package comprising of Sales, Service, Spares, Derrick Crane, Rentals, Fabrication and Re-Furbishment. We SALE world class high quality Lifting Equipments. Our SERVICE determines more economical & superior quality of work to meet expectation of Construction Industry. We provide Genuine SPARE PARTS.

Our success has been built on the foundation of ability to understand customers need and provide machinery support which increases their Profitability & Satisfaction. With best of our engineers, technicians and high service standards, we offer unparalleled after sales support to ensure the equipment provide maximum output with minimum downtime.

Mission:

Orange Machinetech Pvt. Ltd. is committed to simplify equipment **SALES, SERVICE & SPARE PARTS** jobs in Construction Equipment Industry & create feeling of "PROUD ASSOCIATION" in the mind of **Customers, Employees and Vendors.**

Vision:

Orange Machinetech Pvt.Ltd aspires to become the most favourable "SOLUTION PROVIDER" in Construction Equipment Industry.

Our Directors



Er.ROHIT BADKI
DIRECTOR



Er.ATUL MANKAR
DIRECTOR



Er.ABHINEET KUMAR
DIRECTOR

OUR PRODUCT RANGE

- **TOWER CRANES**

Hammer Head: 5Ton to 100Ton

Luffing Type: 6Ton to 80Ton

Flat Top Type: 5Ton to 100Ton

- **DERRICK CRANES**

Luffing Type: 4Ton to 20Ton

- **HOISTS**

Passenger Hoist: 1Ton to 3.5Ton

- **MOBILE TRUCK CRANES**

Truck mounted: 40Ton to 1000Ton

All Terrain: 50Ton to 500Ton

Rough Terrain: 50Ton to 100Ton

- **CRAWLER CRANES**

Crawler mounted: 55Ton to 1000Ton

- **EQUIPMENT RENTALS :**

-Pilling Rigs

-Tower Cranes

-Derrick Cranes

-Passenger Hoists

-Mobile Tower Cranes



ORANGE believes in providing genuine Mechanical & Structural Spare Parts to keep your equipment running at peak performance by reducing its downtime and maintenance cost.

MECHANICAL & STRUCTURAL SPARE PARTS:

 <p>Brake Disc- Liner</p>	 <p>Elastic Coupler</p>	 <p>Pulley</p>	 <p>Chair & Joystick</p>
 <p>Operator Cabin</p>	 <p>Hoist-trolley-Slew Mechanism</p>		 <p>Hook Assembly</p>
 <p>Rope Lock</p>	 <p>Slewing Ring</p>		 <p>Mast Pin</p>
 <p>10.9 Grade Nut-Bolt</p>			 <p>Cotter Pin</p>
 <p>Fixing Angles, Outrigger</p>	 <p>C-Frame & Collar</p>	 <p>Mast Section-cage-conversion kit</p>	

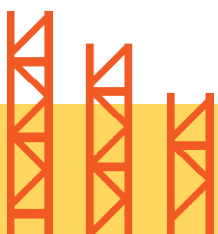

ORANGE believes in providing genuine Electronics & Electrical Spare Parts to keep your equipment running at peak performance by reducing its downtime and maintenance cost.

ELECTRONICS & ELECTRICAL SPARE PARTS:

 <p>Control Panel MCB</p>	 <p>Contactor</p>	 <p>Relay-ON / off</p>	 <p>RCV Block</p>
 <p>Program Logic Controller (PLC)</p>		 <p>Schneider Altivar 61 0.37 kW - 0.55 kW 200 V/230 V</p>	
 <p>Panel Circuit Control Card</p>			
 <p>Hoist-Slew-Trolley Mechanism Motor & Blower Motor</p>		 <p>Potentiometer</p>	

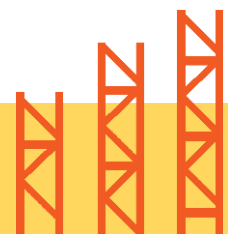







ORANGE believes in providing genuine Safety Devices & Accessories to keep your equipment running at peak performance by reducing its downtime and maintenance cost.

SAFETY DEVICE

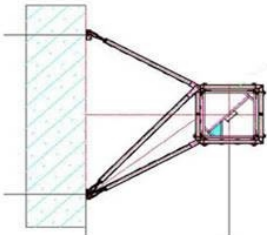
 <p>Aviation Lamp</p>	 <p>Emergency Button</p>	 <p>Lightning Arrester</p>	 <p>Moment Limit</p>
 <p>Safe load Indicator (SLI)</p>	 <p>Limit Switches: Hoist-Trolley-Slew</p>		 <p>Wind Anemometer</p>

ACCESSORIES

 <p>Concrete Bucket</p>	 <p>Sling / D-Shackle / Belt</p>	 <p>Anchorage - TIE BAR</p>
 <p>Material Cage</p>	 <p>Sling / D-Shackle / Belt</p>	 <p>Collar I - BEAM</p>

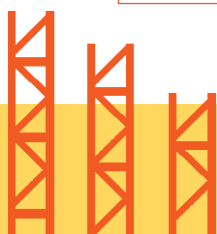

ORANGE believes in providing Fabrication of Structural & Mechanical Parts as per designs, drawings & metallurgy of the tower crane, derrick crane & passenger hoist manufacturers.

STRUCTURAL & MECHANICAL PARTS

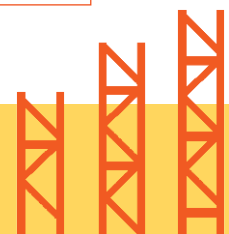

ORANGE Team is equipped & capable to undertake turnkey refurbishment Jobs of Tower Crane (hammer head, Flat top, luffing type) and Passenger Hoist. Scope of refurbishment will depends on condition of equipment which may includes entire structure scrubbing - epoxy priming - painting, overhauling of all mechanisms, rewinding of all motors, alignment of slew ring, repair of operator cabin, re-wiring of control panel, replacement with new safety devices (like limit switches, anemometer, aviation lamp, moment limits etc.), new wire ropes, new fibre pulleys. Our refurbishment team is fully trained and competent to provide you with a professional service.

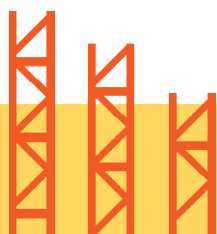

ORANGE after sales support team is equipped & capable to undertake turnkey maintenance jobs at PAN INDIA basis. Our Erection, Dismantling & routine maintenance team are fully trained and competent to provide you with a professional installation of Tower Crane & Passenger Hoist. Our team always ensures that your equipment always remains in top working condition.

AFTER SALES SUPPORT RANGE:

- Third Party Inspection
- Machine Health Check – Up
- Operator & Signal Man Training
- Operation & Maintenance (O&M)
- Annual Maintenance Contract (AMC)
- Site to Site Transportation of Equipment
- Technical Support: Mechanical & Electrical
- Provide Operators, Signalmen, Supervisors and Electricians
- Mast addition, Anchorage fixing & Climbing/Jacking of Internal Tower Crane
- Erection & Dismantling (including Manpower, Supervisor, Rigger, Telescopic Truck Crane & Hydra)



TRAINING

ORANGE provides customers with a comprehensive product training programs aimed at technicians who work with, install, use or maintain the equipment at project site.

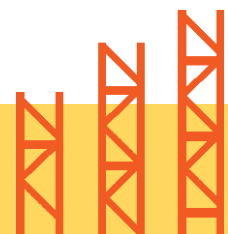



RELIANCE TWIN TOWER Ghansoli [Mumbai]



LODHA THE PARK Worli [Mumbai]



LODHA WORLD ONE Lower Parel [Mumbai]



SHAPOORJI PALLONJI SAROVA Kandavali [Mumbai]



HIRANANDANI ONE PARK Thane [Mumbai]



KALPATARU IMMENSA Thane [Mumbai]



SUNTECK CITY Goregaon [Mumbai]



RUSTOMJEE CROWN Prabhadevi [Mumbai]

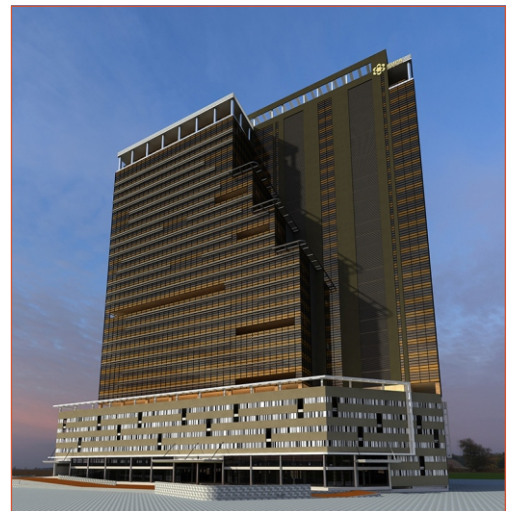

RUPA RENAISSANCE- EVERSENDAI [Mumbai]



NYATI ELYSIA Kharadi [Pune]



ROHAN ABHILASHA Wagholi [Pune]



APARNA LUXOR [KONDAPUR]



GODREJ GREENS UNDRI [Pune]



PANCHSHIL BALEWADI HIGH STREET [Pune]

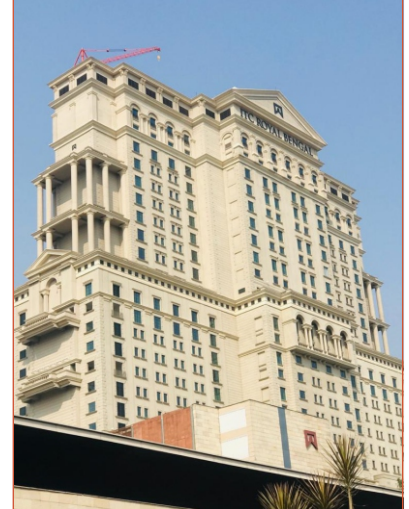

ITC ROYAL BENGAL [Kolkata]



MANTRI-SERENITY [Bangalore]



SOBHA INDRAPRASTHA [Bangalore]



M3M LATITUDE-TATA PROJECTS LTD [Delhi]

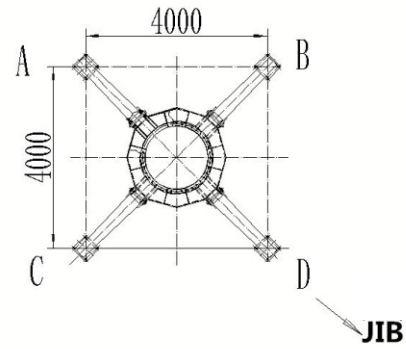
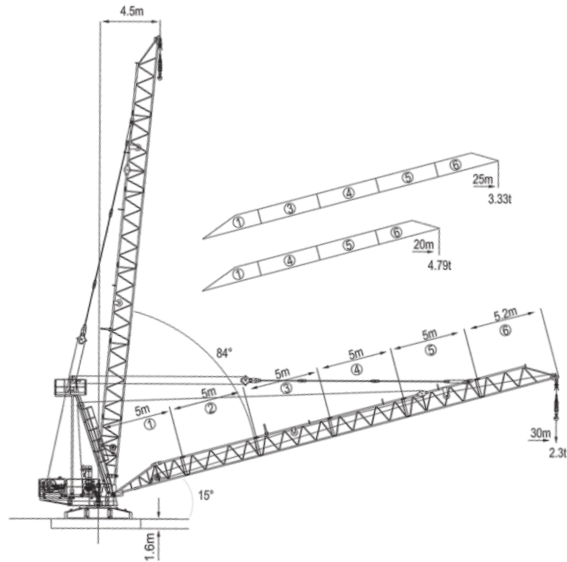

		A(KN)	B(KN)	C(KN)	D(KN)
IN SERVICE	250pa	-225	65	65	355
OUT OF SERVICE	1100pa	-100	40	40	180

Load Diagrams

Jib(m)	Fall	Range (m)																		
		4.5-10.65	11	12	14.16	15	17.5	18.65	20	23	25	28	30							
30	IV III II	Luffing Degree		84°	69.3°	67.3°	64°	61.1°	55.7°	55.7°	49.9°	42.2°	36.4°	25.6°	15°					
		Load (t)		10	9.35	8.38	7.35	6.26	5	4.7	4.13	3.3	2.85	2.31	2					
		7.5											6.41	5.15	4.85	4.28	3.45	3.0	2.46	2.15
		5											4.43	3.6	3.15	2.61	2.3			

Jib(m)	Fall	Range (m)																	
		4.5-10.8	11	12	14.34	15	18	18.05	19	20	23	25							
25	IV III II	Luffing Degree		84°	64.9°	62.4°	57.6°	54.6°	45.9°	45.8°	43.6°	39.4°	27.3°	15°					
		Load (t)		10	9.53	8.57	7.35	6.44	5.02	5	4.7	4.31	3.4	3.03					
		7.5											6.59	5.17	5.15	4.85	4.46	3.55	3.18
		5											4.61	3.7	3.33				

Jib(m)	Fall	Range (m)												
		4.5-11	12	14.63	15	18	18.6	19.54	20					
20	IV III II	Luffing Degree		84°	54.6°	46.7°	43.6°	29.6°	26.1°	21.1°	15°			
		Load (t)		10	8.75	7.35	6.62	5.2	5	4.7	4.49			
		7.5								6.78	5.35	5.15	4.85	4.64
		5								4.79				

Load Diagrams

Item	Mechanism	⚙️		⚙️		🌀 m	Power
		m/min	t	m/min	t		
Hoisting	60LVF25	0-22.5	10	0-45	5	600	45Kw
		0-45	5	0-90	2.5		
Slewing	RCV185	0-0.7r/min		Ferquency control			9Kw
	RVF185						9Kw
Luffing	33DVF30	≤3min		Ferquency control			24Kw
Mains supply		CE138 ICE38				380V(±5%)/50Hz 440V(±5%)/60Hz	
Necessary electric power							120KVA

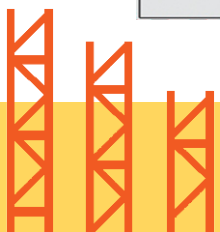

Radius of Slewing & Load

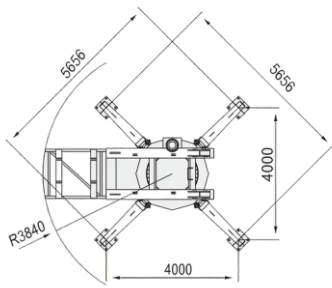

Radius of counter-jib	3.84m
Radius of tail	2.83m
Max pressure of fixing angle	35.5t
Max tension of fixing angle	28t

The crane load and Foundation

Max Load of the Outrigger					
outrigger distance	Tension Legs	Compression outrigger	dead-weight	Load	
L (M)	R1 (KN)	R2 (KN)	G (T)	Q(T)	
4000x4000	280	355	16t	10	

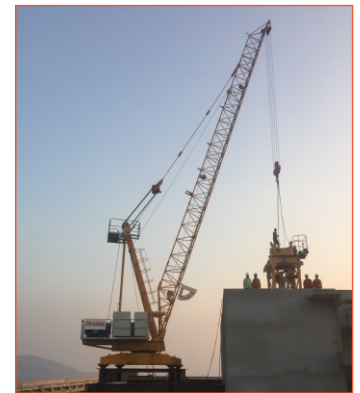

Dimension & Weight

No.	Name	Description	L(m)	W(m)	H(m)	Weight(Kg)	Qty
1	Slewing table		5.17	3.57	1.77	2758	1
2	Support Leg		6.08	6.08	0.73	3872	1
3	Jib-Section1		5.18	1.39	1.43	607	1
4	Jib-Section2		5.1	1.34	1.37	464	1
5	Jib-Section3		5.1	1.34	1.30	346	1
6	Jib-Section4		5.14	1.34	1.36	456	1
7	Jib-Section5		5.26	1.34	1.71	450	1
8	Towerhead		7.87	2.07	4.18	2534	1
9	Hook		1.14	0.24	1.72	321	1

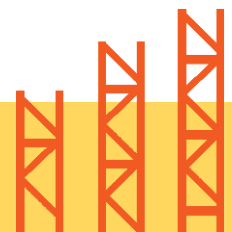

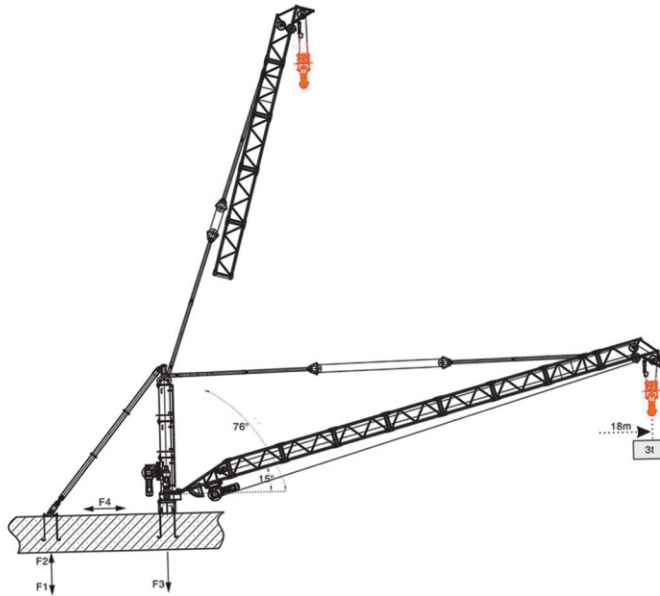

F1	20t	F3	26t
F2	20t	F4	16t
		4.5t	

自重 Total weight without load

Load Diagrams & Mechanisms

Jib (m)	Fall	Load (t)	Range (m)					
			5.3	7.5	10	13	15	18
			Luffing Degree					
			76°	67.35°	58.17°	45.63°	35.83°	15°
18	II		4					3
	I		2					

The following special load chart with one fall (single rope) is only for temporary use within 25 minutes.

Jib(m)	Fall	Range (m)	Load (t)
18	I	18	2.215

Mechanisms Specifications							KW		
Hoisting		10LVF20	t	2	1	4	2	420m Inverter Control	7.5
			m/min	0-20	0-40	0-10	0-20		
Luffing		10DVF20	min	≤3.0		Inverter Control		88m	7.5
Slewing		5RVF	r/min	0-0.7		Inverter Control			4
Power Supply				380V/50Hz 415V/50Hz 440V/60Hz					
Necessary Power				24KVA					
Generator Sets				Consult us					

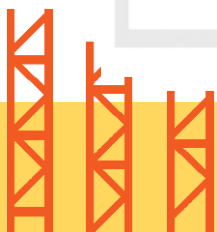

Main Components Dimensions and Weights

Name	No	Dimension	L(mm)	W(mm)	H(mm)	Weight (kg)
Upper Slewing	1		790	634	351	134
Lower slewing	1		400	620	620	101
Jib No.1	1		2100	560	700	109
Jib No.2	5		2100	560	700	82
Jib No.3	2		2100	560	700	91
Jib nose	1		2225	560	1280	103
Lower mast	1		1982	508	584	214
Upper mast	1		1982	520	584	197

mast top	1		739	520	520	175
hoist mechanism	1		1330	620	1170	500
luffing mechanism	1		730	620	1170	448
upper support leg	2		2020	250	250	85
Mid-support leg	2		1970	250	250	84
low support leg	2		2670	250	250	145
pulley set	2		460	420	510	110
lower loading beam	1		2006	160	260	29
upper loading beam	1		2000	110	710	42
electrical cabinet	1					

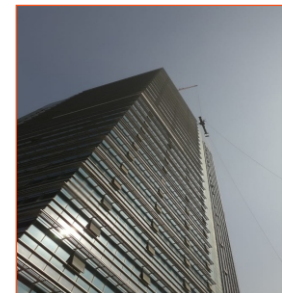
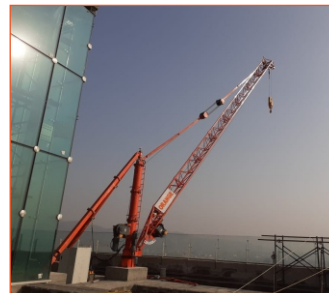
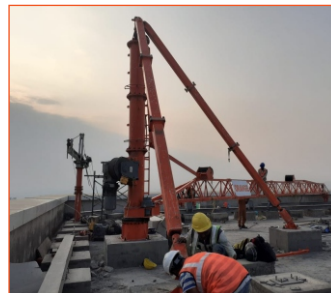

ORANGE (FOSOW & Hi-TECH) Tower Crane Anti-Collision System (ACD) & Safe Load Indicator (SLI) can be used for various luffing, level-jib, fixed type and travel type tower cranes. This system protects the jib and hook of the tower crane. When encountering obstacles, the system can intelligently control the stopping distance according to tower crane operation speed, wind speed and etc. It applies to any tower head, flat arm and swing arm tower crane. The system is designed specially to solve the problem that tower crane needs to change security monitoring device in different environments constantly, only by adding fittings, functions of two sets of equipment can be achieved, to save 50% cost of ownership.

Anti-Collision Device (ACD)

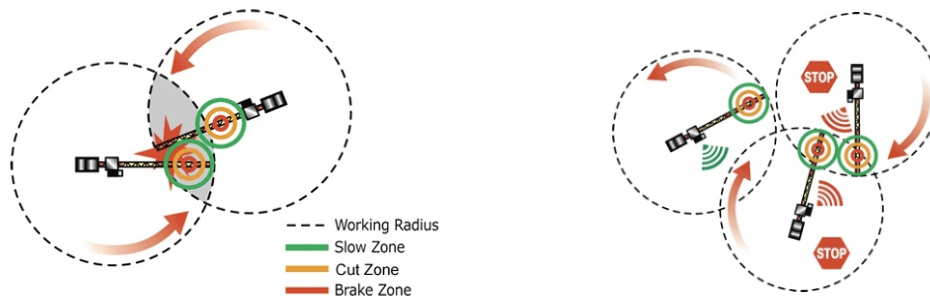

Safe Load Indicator (SLI)

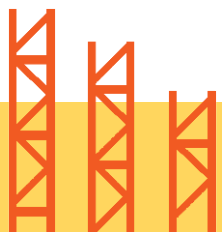

ORANGE Equipment RENTAL division is equipped to handle the entire turnkey requirements of the project sites; We are an Indian rental specialized company in equipments like Tower Crane, Passenger Hoist, Derrick Crane, Mobile Tower Crane & Pilling Rigs were we take care of end to end activity like Transportation, Erection, Operating, Dismantling, Supply spare parts, 3rd Party Inspections etc. as per clients & project requirements. Equipment Rentals can be provided on PAN INDIA basis. Our entire team is fully trained and competent to provide you with a professional service. Our team always ensures that our rental fleet of equipment always remains in top working condition. We offer unparalleled after sales support to ensure the rental equipment provide maximum output with minimum downtime.



Derrick Cranes



Pilling Rigs



Mobile Tower Cranes



Tower Cranes

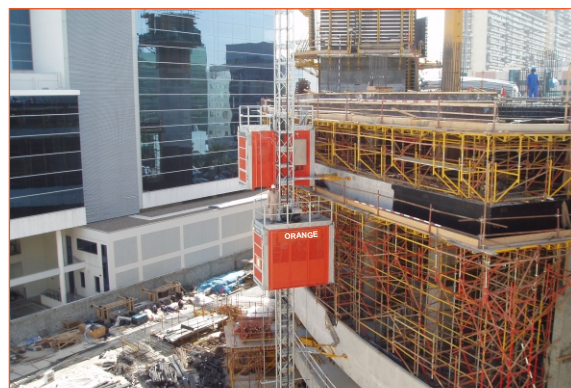

Passenger Hoists

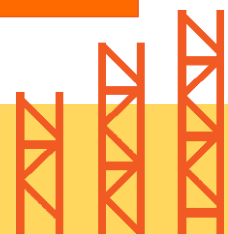

Safdor Engineering Pvt. Ltd. is a Joint Venture Company of M/s SA Syncon Infrastructure Services (I) Pvt. Ltd. & M/s Orange Machinetech Pvt. Ltd., located in Mumbai focusing on upcoming & ongoing Metro & High Speed Railway Projects in India. Safdor Engineering has in-house expertise to take up all activities of Tunnel Boring Machines. The scope includes TBM Assembling, Advancing, & Maintenance. Safdor has successfully executed two such jobs in Delhi Metro for L&T SUCG JV in the period between 2013-2015. Package CC-05 & CC-27 were completely executed by Safdor. With such expertise Safdor can provide complete solution for Metro & High Speed Railway Projects.



Launching Girder (Metro)



Tunnel Boring Machine (TBM)



Launching Girder (Bullet Train)



Foundation Crane HD



Pilling Rig HD



Bridge Inspection Unit



Wind Mill Crane



Pipe Layer & Pay Welder

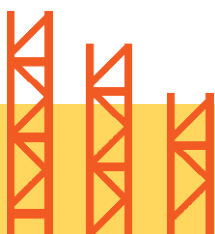

Hiranandani creating better communities	B. E. Billimoria & Co. Limited	CAPACITE	ILFS	Godrej	Cem Commitment, Reliability & Quality	MRCI MRCI Infrastructures & Projects Ltd.
KALPA-TARU	LODHA BUILDING A BETTER LIFE	MILLENNIUM	MAN REALTY INTELLIGENT LIVING	PARANJPE SCHEMES The Spirit of New India	RADIUS A SPACE FOR YOUR IDEAS BUILT AROUND YOU	Rajesh LifeSpaces Crafting spaces, creating legacies
ROHAN BUILDERS (INDIA) PVT. LTD.	RUBBERWALA building dreams	AL FARA'A GROUP CONSTRUCTION • PROPERTIES • INDUSTRIES	Kustomjee	SJSJ CONSTRUCTION INC. serving the community since 1992	DHEERAJ	VASCON ENGINEERS Building Future Perfect
TATA	SIMPLEX INFRASTRUCTURES	RUNWAL Since 1978 With you, always...	RUNAL THE MARK OF YOU	RNA CORP. HABITATS IN HARMONY	LEIGHTON	KANAKIA PERFECTION ALL THE WAY
K RAHEJA CORP	Indiabulls	omkar	Sunteck	NYATI GROUP Building Relationships	JMC PROJECTS (INDIA) LIMITED (A Kalpataru Group Enterprise)	REGENCY GROUP Linking People, Building Trust
SURAJ	ITC Limited	PENINSULA LAND CREATING INTERNATIONAL LANDMARKS	Reliance	APARNA Lead the future	EVERSENDAL Towering—Powering—Energising—Innovating	Shapoorji Pallonji Built to last... since 1865



Sales Services & Spare Parts Network

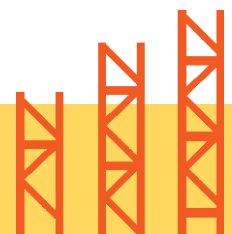



Tower Cranes



Crawler Cranes



Construction Hoist

🏠 Orange Machinotech Pvt Ltd. 3rd Floor, B25, Big Bazar,
High Street Mall, Majiwada Circle, Thane West

☎ +91 8879151567, +91 9890988511, +91 7506102667

✉ rohit.badki@orangemachinotech.com
atul.mankar@orangemachinotech.com
abhineet.kumar@orangemachinotech.com

👤 Rohit Badki, Atul Mankar, Abhineet Kumar